



SOUNDWELL®

http://soundwell-cn.com

RA09 Series POTENTIOMETER



企业微信，扫码有惊喜



升威官网，发现更多产品

MODEL 品名	DIMENSIONS 尺寸	UNIT:mm
----------	---------------	---------

RA0921NO Z0X-VA1

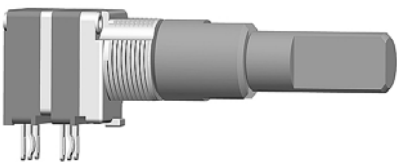
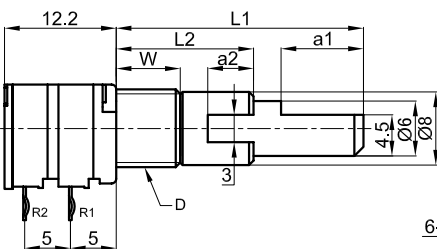
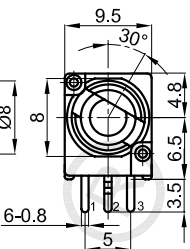
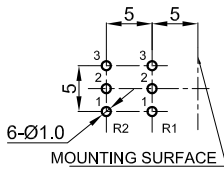
SHAFT SHOWN IN FULL C.C.W. POSITION

P.C.B. MOUNTING HOLE DETAIL

RA0921EO Z0X-VA1

SHAFT SHOWN IN FULL C.C.W. POSITION

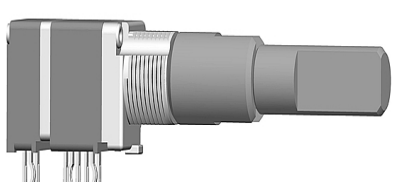
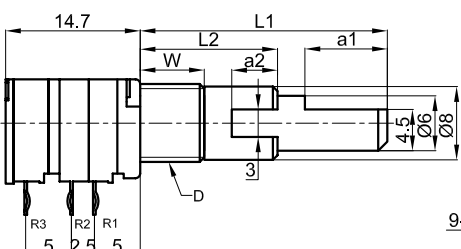
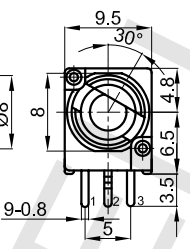
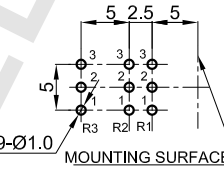
P.C.B. MOUNTING HOLE DETAIL

RA0921GO Z0X-VA1

SHAFT SHOWN IN FULL C.C.W. POSITION

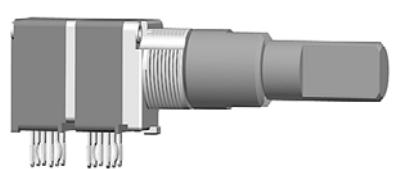
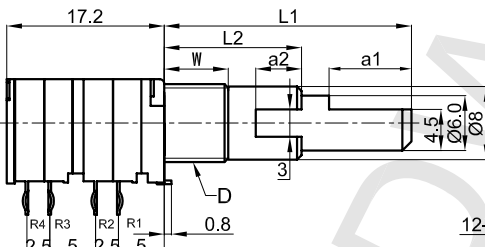
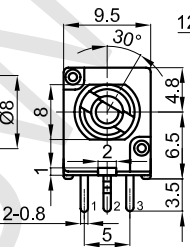
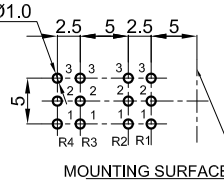
P.C.B. MOUNTING HOLE DETAIL

W	D	Z
5.0	M7x0.75	A
7.0	M7x0.75	B
10.0	M7x0.75	C
5.0	M9x0.75	D
4.0	M9x0.75	E
7.0	M9x0.75	M

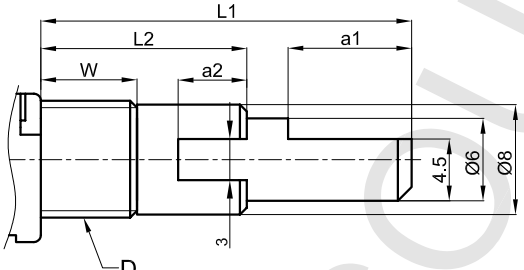
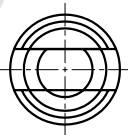
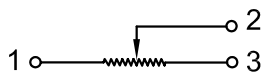
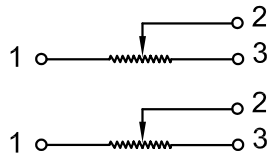
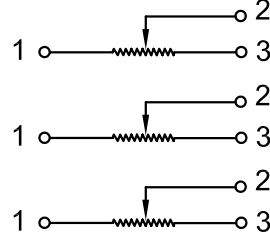
L1	16	19	20	20	21	29	30
a1	5	8	5	7	4	7	12
L2	10	10	10	11	13	17.5	15
a2	4	4	4	5	3	4	5

RA0921 SERIES CIRCUIT DIAGRAM

<p>NO</p> 	<p>GO</p> 	<p>EO</p> 
--	--	--